

# Insulation Testers

## Battery Powered Insulation Testers

● Analog Models

- 3213A** Single range
- 2406E** 2 and 3 ranges
- MY10** Single range

● Digital Models

- 2406D** Single and 2 ranges
- MY40** 4 ranges



3213A  
(110x180x60mm)

2406E  
(120x110x60mm)

MY10  
(125x103x53mm)

2406D  
(120x110x60mm)

MY40  
(125x103x53mm)



ISO9001



ISO14001

## What Is Insulation Resistance?

Insulation resistance represents the state of insulation of electric equipment or circuits. It is one of the important measurement parameters in terms of safety and security. Methods of examining the state of insulation include using a clamp-on leakage tester for live circuits. Under normal circumstances, however, such electric equipment or circuits are shut down temporarily and their insulation is tested with an insulation tester.

## Classification of Applications

Applications are roughly classified into low-voltage, high-voltage and ultra-high-voltage circuits. The table below summarizes examples of using rated test voltages. A tester with the rated test voltage of 500 V or 100 V/250 V is used for low-voltage circuits.

Rated test voltage	General Electric Equipment	Electric Installations/Circuits
	Insulation testing at safe voltage levels	—
25V	For telephone network equipment	—
50	Insulation testing of control equipment	Insulation testing for maintaining low-voltage circuits or equipment handling 100 V or lower levels
100V	Insulation testing of control equipment	Insulation testing for maintaining low-voltage circuits or equipment handling 200 V or lower levels
125V 250V	Insulation testing of control equipment	Insulation testing for maintaining low-voltage circuits or equipment handling 400 V or lower levels Insulation testing of 100 V, 200 V or 440 V circuits or equipment upon completion of installation
500V	Insulation testing of circuits or equipment handling 300 V or lower levels (general equipment)	Insulation testing of circuits or equipment handling constantly high operating voltages (e.g., high-tension cables, high-voltage electric equipment, and communications equipment handling high voltages)
1000V	Insulation testing of circuits or equipment handling levels higher than 300 V (general equipment)	

## Test Methods for Low-voltage Circuits

Insulation resistance between cables of a low-voltage circuit and between the circuit and ground is tested for each circuit that can be separated by a switch or overcurrent breaker installed as specified by the electrotechnical equipment standards.

The low-voltage circuit is shut down by opening the switch and insulation between cables of the circuit and between the circuit and ground is tested. If the measured value is below the rated resistance, all shunt switches of a trunk line are opened and insulation is tested separately for each shunt circuit.

The comparator function of the MY40 or 2426A series insulation tester allows for smooth judgment when checking the insulation of electric circuits.

## Methods of Scaling the 1st and 2nd Effective Measuring Ranges of Moving-pointer Insulation Testers

Rated test voltage: 25 V  
Maximum effective reading: 5 MΩ

① = First effective measuring range  
② = Second effective measuring range

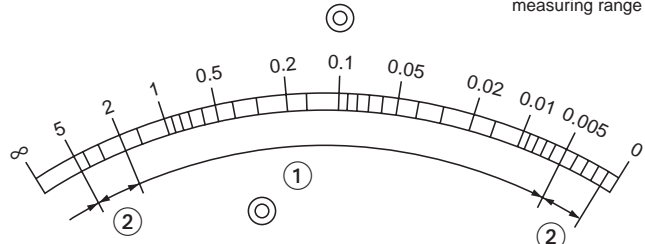

### Maximum effective reading:

The maximum reading that is indicated on the insulation tester and falls within the range with which the accuracy of the insulation tester is guaranteed.

### Effective test range:

A test range or ranges, among those of the insulation tester, over which accuracy specified in the standards is guaranteed. In moving-pointer insulation testers, the range from a resistance value one-thousandth (1/1000) the maximum effective reading to the resistance value that is nearest to half (1/2) the maximum effective reading and equal to the maximum effective reading multiplied by 1, 2 or 5 or by any of these values multiplied by ten (10) raised to a whole-number power, shall be referred to as a first effective measuring range. In addition, the range from the upper limit of the first effective measuring range to the maximum effective reading and the range from the lower limit of the first effective measuring range to the zero (0) reading shall be referred to as second effective measuring ranges (see the figure above). In digital insulation testers, the first and second effective measuring ranges shall be those indicated on the insulation tester (Excerpt from JIS C1302-1994).

## Points on How to Choose an Insulation Tester

# 1

### Type

Two choices:  
Choose an analog model if visual recognition is of utmost importance, or a digital model if precise numeric recognition is of utmost importance.

# 2

### Ratings

A wide choice of voltage/resistance ratings, from 25 V/5 MΩ to 1000 V/2000 MΩ  
Some models have two or three ranges; thus, you need not take more than one instrument to the site.

# 3

### Functionality

Each series includes a model or models with a backlight for working in dark places. Multi-functional models capable of, for example, AC voltage measurement, are also available.

# 4

### Accessories

Optional test probes and probe tips are available for a variety of test environments.

### • General and Common Specifications

**Effect of inclination (analog type):** A change in the infinite scale value (∞) must be no more than 2% of the scale length when the tester is inclined 30° forward or backward and leftward or rightward from the horizontal position.

**Effect of temperature (digital type):** A change in the reading at an ambient temperature of 20°C must be no more than 2.5% at each of the maximum, minimum and central scale values of the first effective measuring range when the temperature is changed by ±20°C from 20°C.

**Effect of temperature (analog type):** A change in the reading at an ambient temperature of 20°C must be no more than 5% at the central scale value and no more than 0.7% of the scale length at either the infinite scale value or the zero scale value when the temperature is changed by ±20°C from 20°C.

**Effect of humidity:** A change in the reading must be within the specified tolerance range when the tester is left to stand for one hour under the relative humidity of 90%.





**Effect of AC voltage component applied to test terminals:** A change in the reading must be no more than 10% when a resistance corresponding to the central scale value is connected to the tester and then a capacitance of 5 μF ±10% is connected in parallel across the resistance.

**Overrange input protection:** No failure must be present when a 50 Hz or 60 Hz AC voltage with an amplitude 1.2 times the rated test range is applied for ten seconds across the test terminals.

**Operating temperature/humidity range:** -10°C to 50°C/90% RH maximum (no condensation)

**Storage temperature/humidity range:** -20°C to 60°C/70% RH maximum (no condensation—batteries should be removed)

# Selection Guide

Type	Series/ Model	Suffix Code & Backlight	Rating	AC Test Voltage Range	Display	Additional Function	External View	Page	
Digital insulation testers	4 ranges	MY40 CE	01 (EL-illuminated)	125V/200MΩ 250V/200MΩ 500V/2000MΩ 1000V/2000MΩ	0-600V	3 1/2-digit LCD	Automatic discharge Conductor resistance measurement Comparator function Memory function		P.3
	Single & 2 ranges	2406D CE	51 (N/A)	125V/200MΩ	0-300V	3 1/2-digit LCD	Automatic discharge		P.4
			61 (LED-illuminated)	250V/200MΩ					
			52 (N/A)	125V/200MΩ	0-300V				
			62 (LED-illuminated)						
			53 (N/A)	250V/200MΩ	0-300V				
			63 (LED-illuminated)						
			54 (N/A)	500V/200MΩ	0-600V				
			64 (LED-illuminated)						
	55 (N/A)	1000V/2000MΩ	0-600V						
65 (LED-illuminated)									
Analog insulation testers	2 & 3 ranges	2406E CE	31 (N/A)	25V/5MΩ	0-300V	Analog	Automatic discharge Battery check		P.5
			41 (EL-illuminated)	50V/10MΩ 125V/20MΩ					
			32 (N/A)	125V/20MΩ	0-300V				
			42 (EL-illuminated)	250V/50MΩ					
			33 (N/A)	125V/20MΩ	0-600V				
			43 (EL-illuminated)	250V/50MΩ 500V/100MΩ					
			34 (N/A)	250V/50MΩ	0-600V				
			44 (EL-illuminated)	500V/100MΩ 1000V/2000MΩ					
			35 (N/A)	250V/500MΩ	0-600V				
			45 (EL-illuminated)	500V/1000MΩ 1000V/2000MΩ					
	Single range	MY10 CE	01 (afterglow-illuminated)	125V/20MΩ	0-250V	Analog	Automatic discharge Battery check		P.6
			02 (afterglow-illuminated)	250V/50MΩ	0-300V				
			03 (afterglow-illuminated)	500V/100MΩ	0-500V				
			04 (afterglow-illuminated)	500V/1000MΩ	0-500V				
			05 (afterglow-illuminated)	1000V/2000MΩ	0-500V				
	Single range	3213A	41 (N/A)	100V/20MΩ	0-150V	Analog	Battery check		P.7
			42 (N/A)	250V/50MΩ	0-250V				
			43 (N/A)	500V/100MΩ	0-300V				
			44 (N/A)	500V/1000MΩ	0-300V				
			45 (N/A)	1000V/2000MΩ	0-300V				
46 (N/A)			125V/20MΩ	0-250V					



# MY40 Digital Insulation Tester

# MY40 SERIES

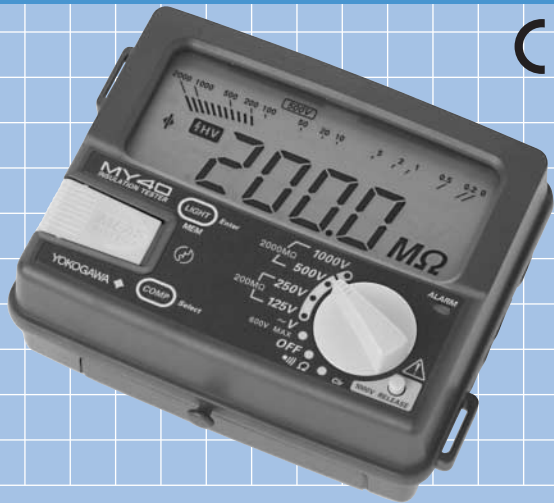

- **Digital model with 4 voltage/resistance ratings**
- **Multifunction**  
Insulation resistance, AC voltage and conductor resistance measurement  
Insulation test mode: Comparator, memory, auto-hold and discharge functions  
All test modes: Live-line alarm (excluding AC voltage measurement), battery check and automatic power-off
- **Easy-to-view, fluctuation-free display**
- **Double-action safety mechanism**



← Protection against inadvertent setting of rotary switch to 1000 V rating

## Testing Performance Specifications

Model	Rating	Range Option	Resolution	Measuring Range	Tolerance	Lower Limit of measured Ω	Rated Current	Central Scale Value
MY40-01	125V/200MΩ	4000	.1kΩ	0–.0199MΩ	± (5% of rdg+6dgt)	0.125MΩ	1mA	5MΩ
		4.000	1kΩ	.0200–20.00MΩ*	± (2% of rdg+6dgt)			
		40.00	10kΩ	20.01–200.0MΩ	± 5% of rdg			
		200.0	100kΩ					
250V/200MΩ	4.000	1kΩ	0–.0499MΩ	± (5% of rdg+6dgt)	0.25MΩ	1mA	5MΩ	
		40.00	1kΩ	.0500–20.00MΩ*				± (2% of rdg+6dgt)
		400.0	10kΩ	20.01–200.0MΩ				± 5% of rdg
		200.0	100kΩ					
500V/2000MΩ	4.000	1kΩ	0–0.999MΩ	± (5% of rdg+6dgt)	0.5MΩ	1mA	50MΩ	
		40.00	10kΩ	1.000–500MΩ*				± (2% of rdg+6dgt)
		400.0	100kΩ	501–2000MΩ				± 5% of rdg
		2000	1MΩ					
1000V/2000MΩ	4.000	1kΩ	0–1.999MΩ	± (5% of rdg+6dgt)	2MΩ	0.5mA	50MΩ	
		40.00	10kΩ	2.000–1000MΩ*				± (2% of rdg+6dgt)
		400.0	100kΩ	1001–2000MΩ				± 5% of rdg
		2000	1MΩ					

\* First effective measuring range; \*\* The minimum value at which the rated voltage can be maintained

### Standard test conditions

Ambient temperature/humidity ranges: 23 ±5 /45-75% RH

Tolerances under the above-mentioned conditions:

Deviation from zero scale value: 6 digits maximum

Indication of ∞ mark on bar graph: Approx. 4000 MΩ min. (500 V/1000 V)

Approx. 400 MΩ min. (125 V/250 V)

No-load voltage: 130% max. of rated voltage

Rated measuring current: 1 mA (0 to 20%) when in first effective measuring range

Short-circuit Current: 2 mA max.

### AC voltage measurement (45-400 Hz)

Model	Range	Resolution	Accuracy	Input Impedance
MY40-01	600V	1V	±(2% of rdg + 6dgt)	Approx. 2 MΩ

### Conductor resistance measurement

Model	Range	Resolution	Accuracy	Open-circuit Voltage
MY40-01	400Ω	0.1Ω	±(2% of rdg + 8dgt)	Buzzer sound resistance: <40Ω

## General Specifications

**Display:** 3 1/2-digit LCD; 4000 count; backlight-illuminated; logarithmic bar graph; extension bar graph—no fluctuations, as the display shows the digits of a reading in the order in which each digit settles.

### Example of Extension Bar Indicator View

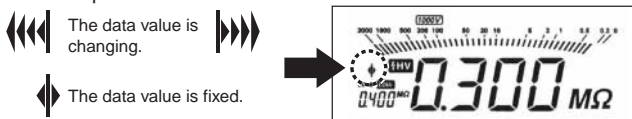

**Comparator function:**The MY40 alerts you by turning on the LOW symbol and sounding the buzzer if the measured value is smaller than the reference value. You can allocate as many as three user-defined reference values to each rating. The factory-set defaults are 0.1 MΩ, 0.2 MΩ and 0.4 MΩ.

**Memory function:**For each rating, you can save as many as 20 measurements at desired memory address numbers.

**Automatic discharge function:**The MY40 automatically begins discharge when you turn off the MEAS switch. You can monitor the state of discharge by checking the bar graph and make sure discharge is complete by checking that the segment bar disappear.

**High-voltage indicators:** The high-voltage symbol and LED lamp come on to alert you when the MY40 is in insulation testing mode or if any voltage remains to be discharged.

**Live-line alarm:**If you apply an AC voltage of approximately 40 V or higher across the input terminals, the MY40 alerts you by blinking the LED lamp and sounding the buzzer.

**Overrange input alarm:** If the voltage being measured exceeds 600 V during AC voltage measurement, the MY40 alerts you by flashing the Maximum Value indicator and sounding the buzzer.

**Auto-hold function:** The tester retains the measured resistance for approximately 5 seconds after the MEAS switch is turned off.

**Dimensions:** 125 (W) × 103 (H) × 53 (D) (mm), excluding protrusions

**Weight:** 420 g (main unit and batteries only, excluding accessories)

**Batteries:** Four AA (R6P) batteries

Note: See the list of accessories on the backside of this bulletin for more information on accessories.

## Standard Accessories

Product	Part Number	Qty
Protection cover	93013	1
Shoulder strap	99005	1
Line probe	98001	1
Earth probe	98002	1
User's manual	—	1
Batteries	—	4

## External Dimensions

Unit: mm

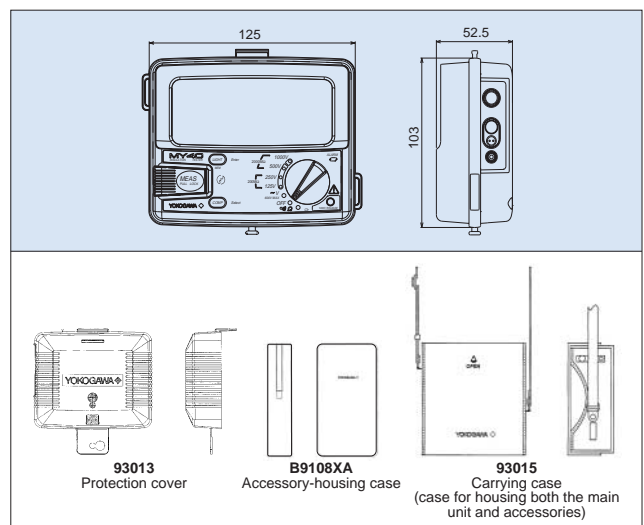

# 2406D Series of Digital Insulation Testers

# 2406D SERIES

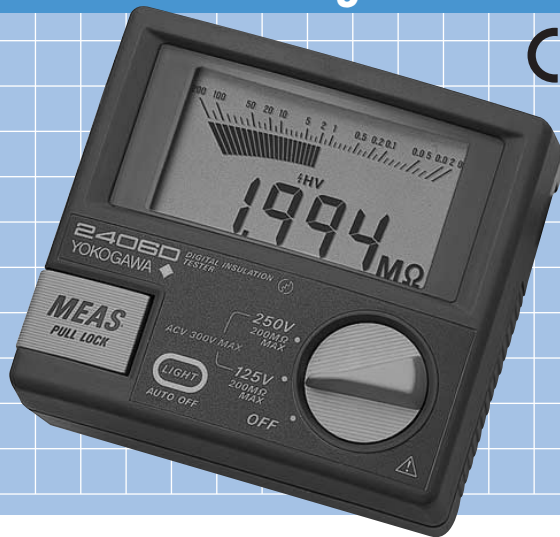

2406 51 2406 52 2406 53 2406 54 2406 55 2406 61  
2406 62 2406 63 2406 64 2406 65

- Digital models with single and two ratings
- AC voltage measurement
- Automatic discharge
- EL backlight
- Addition of 500 V/2000 MΩ model
- Excellent tolerance: 2% of reading + 1 digit (first effective measuring range)

## Testing Performance Specifications

Model	Rating	Range Option	Resolution	Measuring Range	Tolerance	Lower Limit of measured Ω	Rated Current	Central Scale Value
2406 51	125V/	.4000	.1kΩ	0–.0199MΩ	±(5% of rdg + 6dgt)	0.125MΩ	1mA	5MΩ
2406 61	200MΩ	4.000	1kΩ	.0200–10.00MΩ*	±(2% of rdg + 1dgt)			
		40.00	10kΩ	10.01–200.0MΩ	±5% of rdg			
		200.0	100kΩ					
	250V/	.4000	.1kΩ	0–.0499MΩ	±(5% of rdg + 6dgt)	0.25MΩ	1mA	5MΩ
	200MΩ	4.000	1kΩ	.0500–20.00MΩ*	±(2% of rdg + 1dgt)			
		40.00	10kΩ	20.01–200.0MΩ	±5% of rdg			
		200.0	100kΩ					
2406 52	125V/	.4000	.1kΩ	0–.0199MΩ	±(5% of rdg + 6dgt)	0.125MΩ	1mA	5MΩ
2406 62	200MΩ	4.000	1kΩ	.0200–10.00MΩ*	±(2% of rdg + 1dgt)			
		40.00	10kΩ	10.01–200.0MΩ	±5% of rdg			
		200.0	100kΩ					
2406 53	250V/	.4000	.1kΩ	0–.0499MΩ	±(5% of rdg + 6dgt)	0.25MΩ	1mA	5MΩ
2406 63	200MΩ	4.000	1kΩ	.0500–20.00MΩ*	±(2% of rdg + 1dgt)			
		40.00	10kΩ	20.01–200.0MΩ	±5% of rdg			
		200.0	100kΩ					
2406 54	500V/	.4000	.1kΩ	0–.0999MΩ	±(5% of rdg + 6dgt)	0.5MΩ	1mA	5MΩ
2406 64	200MΩ	4.000	1kΩ	.1000–50.0MΩ*	±(2% of rdg + 1dgt)			
		40.00	10kΩ	50.1–200.0MΩ	±5% of rdg			
		200.0	100kΩ					
2406 55	1000V/	4.000	1kΩ	0–1.999MΩ	±(5% of rdg + 6dgt)	1MΩ	1mA***	50MΩ
2406 65	2000MΩ	40.00	10kΩ	2.000–1000MΩ*	±(2% of rdg + 1dgt)			
		400.0	100kΩ	1001–2000MΩ	±5% of rdg			
		2000	1MΩ					

\* First effective measuring range; \*\* The minimum value at which the rated voltage can be maintained; \*\*\* 0.55 mA in the case of the lower limit of the first effective measuring range

Non-backlit LED-backlit

### Standard test conditions:

Ambient temperature/humidity ranges: 23 ±5 /45-75% RH

Position of use: Unrestricted

Effect of geomagnetism: None

Low-battery alarm: The battery symbol on the LCD comes on for a battery voltage level of 7 V ±0.5 V or lower.

No-load voltage: 130% max. of rated voltage

Rated measuring current: 1 mA (0 to 20%) when in first effective measuring range

Short-circuit current: 12 mA max.

### AC voltage measurement specifications

Model	Range	Resolution	Accuracy	Input Impedance
2406 51, 52, 53 2406 61, 62, 63	300V	1V	±(1.5% of rdg + 6dgt)	Approx. 1.5 MΩ
2406 54, 55 2406 64, 65	600V	1V	±(1.5% of rdg + 6dgt)	Approx. 1.5 MΩ

### Large switch for better operation



## General Specifications

**Discharge function:** The tester automatically discharge when you turn off the MEAS switch. The segment bar extends if there is any residual voltage in the circuit under test. You can make sure discharge is complete by checking that the segment bar disappears from the display. Under this condition, the tester is ready to enter voltage measurement mode.

**AC voltage measurement:** The tester enters AC voltage measurement mode when you turn on the power (rotary) switch.

**Auto-hold function:**

The tester retains the measured resistance for approximately 5 seconds after the MEAS switch is turned off.

**Display:** 3 1/2-digit LCD; 4000 count maximum; 42-segment, logarithmic bar graph; overrange input indicator—the OL symbol comes on if the measured value exceeds 2000 count (200.0 range).

**MΩ range selection:**

Fully automatic ranging

**Range step-up:**

The tester shifts the range one step upward for input levels higher than 4000 count.

**Range step-down:**

The tester shifts the range one step downward for input levels lower than 360 count.

**Dimensions (main unit):** Approx. 120 (W) × 110 (H) × 60 (D) (mm)

**Weight:** Approx. 500 g (including batteries)

**Batteries:** Six AA (R6P) batteries

Note: See the list of accessories on the backside of this bulletin for information on accessories.

## External Dimensions

Unit: mm

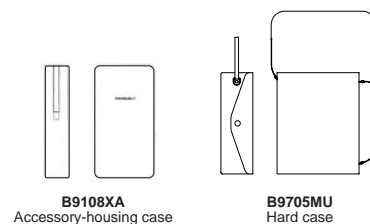
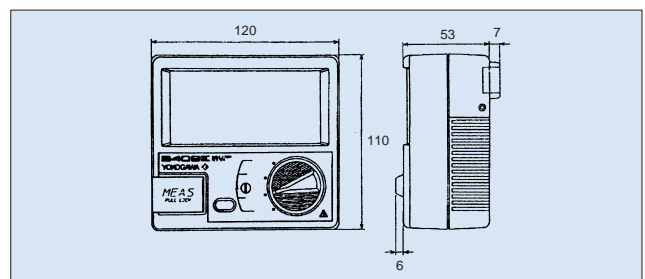

## Standard Accessories

Same as those of the 2406E series.

# 2406E Series of Analog Insulation Testers

# 2406E SERIES

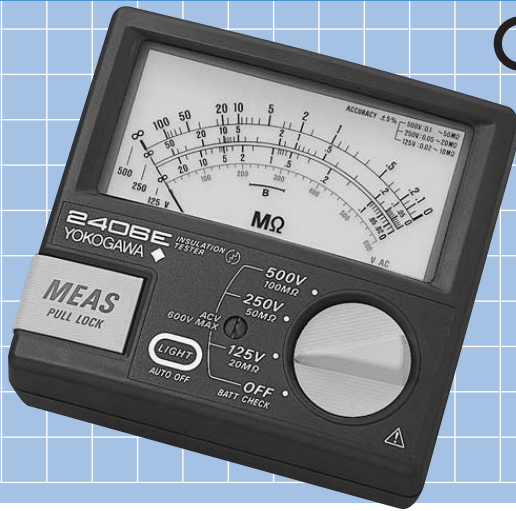

2406 31 2406 32 2406 33 2406 34 2406 35 2406 41  
2406 42 2406 43 2406 44 2406 45

- Analog models with two and three ratings
- AC voltage measurement
- Automatic discharge
- Sky blue EL backlight
- Increased safety (covered battery charger)

## Testing Performance Specifications

Model	Rating	Effective Measuring range	Central Scale Value	AC Voltage Measuring range	Lower limit of measured Ω	Rated Current
2406 31	25V/5MΩ	0.001-5MΩ	0.1MΩ	0-300V	0.025MΩ	1mA
2406 41	50V/10MΩ	0.005-10MΩ	0.2MΩ		0.05MΩ	1mA
	125V/20MΩ	0.01-20MΩ	0.5MΩ		0.125MΩ	1mA
2406 32	125V/20MΩ	0.01-20MΩ	0.5MΩ	0-300V	0.125MΩ	1mA
2406 42	250V/50MΩ	0.01-50MΩ	1MΩ		0.25MΩ	1mA
2406 33	125V/20MΩ	0.01-20MΩ	0.5MΩ	0-600V	0.125MΩ	1mA
2406 43	250V/50MΩ	0.01-50MΩ	1MΩ		0.25MΩ	1mA
	500V/100MΩ	0.05-100MΩ	2MΩ		0.5MΩ	1mA
2406 34	250V/50MΩ	0.01-50MΩ	1MΩ	0-600V	0.25MΩ	1mA
2406 44	500V/100MΩ	0.05-100MΩ	2MΩ		0.5MΩ	1mA
	1000V/2000MΩ	1-2000MΩ	50MΩ		1MΩ	1mA**
2406 35	250V/500MΩ	0.1-500MΩ	10MΩ	0-600V	0.25MΩ	1mA**
2406 45	500V/1000MΩ	0.5-1000MΩ	20MΩ		0.5MΩ	1mA**
	1000V/2000MΩ	1-2000MΩ	50MΩ		1MΩ	1mA**

EL-backlit    Non-backlit    \* The minimum value at which the rated voltage can be maintained;  
\*\* 0.55 mA in the case of the first effective measuring range

### Standard test conditions:

Ambient temperature/humidity ranges: 23 ±5 /45-75% RH

Position of use: Horizontal (5° max. of angle of inclination)

External magnetic fields: None

Battery voltage: Within effective voltage range

(The pointer must stay within the range indicated by the BAT symbol when the battery check is performed.)

### Tolerances under the above-mentioned conditions:

Resistance measurement: First effective measuring range = ±5% of reading

Second effective measuring range = ±10% of reading

Infinite and zero scale values: 0.7% max. of scale length

AC voltage: ±10% of maximum scale value

No-load voltage: 130% max. of rated voltage

Rated measuring current: 1 mA (0 to 20%) when in first effective measuring range

Short-circuit current: 12 mA max.

## General Specifications

**Scale length:** Approx. 86 mm (outer scale)

**Discharge function:** The tester automatically begins discharge when you turn off the MEAS switch. The pointer swings if there is any residual voltage in the circuit under test. You can make sure discharge is complete by checking that the pointer swings back to the infinite (∞) scale value. Under this condition, the tester is ready to enter voltage measurement mode.

**AC voltage measurement:** AC voltage measurement is possible wherever the rotary switch is positioned.

**Dimensions (main unit):** Approx. 120 (W) × 110 (H) × 60 (D) (mm)

**Weight:** Approx. 500 g (including batteries)

**Batteries:** Six AA (R6P) batteries

**Accessories:** See the list of accessories on the backside of this bulletin for information on accessories.

## External Dimensions

Unit: mm

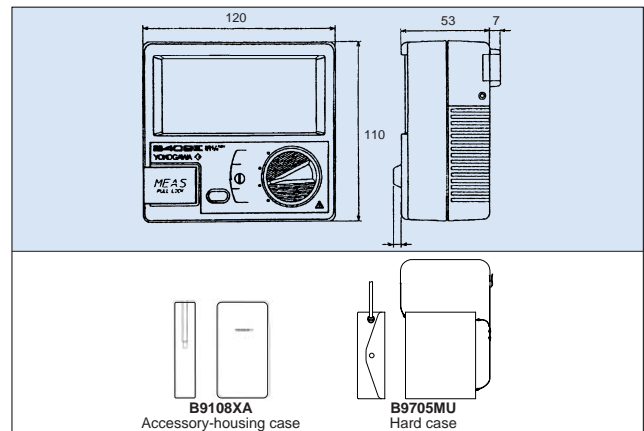

## Standard Accessories

Product	Part Number	Qty	Remarks
Earth and Line probes	98007	1	Earth probe(blake);approx. 1m long Line probe(vermilion);approx. 1m long
Carrying case	B9705MU	1	w/probe-housing pocket and neck strap
User's manual	-	1	-
Batteries	-	6	-

# MY10 Series of Analog Insulation Testers

**MY10**  
SERIES



- **Analog models with single rating**  
MY10-01:125V/20MΩ  
MY10-02:250V/50MΩ  
MY10-03:500V/100MΩ  
MY10-04:500V/1000MΩ  
MY10-05:1000V/2000MΩ
- **AC voltage measurement**
- **Automatic discharge**
- **A wide choice of accessories**  
–Designed for shared use with the MY40

## Testing Performance Specifications

Model	Rating	Effective Measuring Range	Central Scale Value	AC Voltage Measuring Range	Lower Limit of Measured Ω*	Rated Current
MY10-01	125V/20MΩ	0.01–20MΩ	0.5MΩ	0–250V	0.125MΩ	1–1.2mA
MY10-02	250V/50MΩ	0.01–50MΩ	1MΩ	0–300V	0.25MΩ	1–1.2mA
MY10-03	500V/100MΩ	0.05–100MΩ	2MΩ	0–500V	0.5MΩ	1–1.2mA
MY10-04	500V/1000MΩ	0.5–1000MΩ	20MΩ	0–500V	1MΩ	0.5–0.6mA
MY10-05	1000V/2000MΩ	1–2000MΩ	50MΩ	0–500V	2MΩ	0.5–0.6mA

\* The minimum value at which the rated voltage can be maintained

### Standard test conditions:

Ambient temperature/humidity ranges: 23 ±5 /45-75% RH  
Position of use: Horizontal (5° max. of angle of inclination)  
Effect of geomagnetism: None  
Battery voltage: Within effective voltage range  
(The pointer must stay within the range indicated by the BAT symbol when the battery check is performed.)

### Tolerances under the above-mentioned conditions:

Resistance measurement: First effective measuring range = ±5% of reading  
Second effective measuring range = ±10% of reading  
Infinite and zero scale values: 0.7% max. of scale length  
AC voltage: ±10% of maximum scale value  
No-load voltage: 130% max. of rated voltage  
Rated measuring current: 1 mA (0 to 20%) when in first effective measuring range  
Short-circuit current: 12 mA max.

## General Specifications

**Overall scale length:** Approx. 107 mm; afterglow-illuminated scale plate

**AC voltage measurement:** If any AC voltage is present across the test terminals, the tester lets you know by pointing to an AC voltage value and turning on the LED lamp. You can perform AC voltage measurement with the MEAS switch turned off.

### Additional functions:

- Automatic discharge function  
- If the object under test remains electrified after the MEAS switch is turned off, the tester lets you know by turning on the LED lamp. If you leave the tester connected to the electrified object, the tester automatically begins to discharge electricity and then finishes discharging—the LED lamp comes on and then goes out.  
- When the object under test is capacitive and electrified, the tester lets you know by turning on the LED lamp. When left connected to the object, the tester automatically discharges electricity, thus preventing possible electric shock or spike noise at power-on.
- Battery check (BAT mark on the scale plate)

**Battery life:** Approx. 10 hours when continuously operated on manganese-oxide batteries with the pointer pointing to the central scale value.

**Batteries:** Four AA (R6P) batteries

**Dimensions:** Approx. 125 (W) × 103 (H) × 53 (D) (mm), excluding protrusions

**Weight:** Approx. 500 g (main unit and batteries only, excluding accessories)

**Compliance:** EN61010-1:1993; EN61010-2-31:1995  
(Overvoltage Category III, Pollution Degree 2 installations for indoor use)

## Standard Accessories

Product	Part Number	Qty
Protection cover	93013	1
Shoulder strap	99005	1
Line probe	98001	1
Earth probe	98002	1
User's manual	–	1
Batteries	–	4

## External Dimensions

Unit: mm

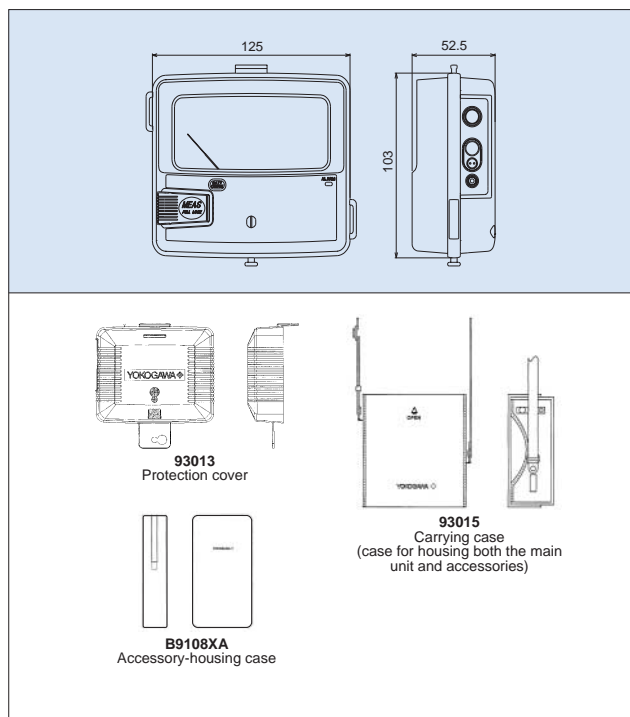



# 3213A Series of Analog Insulation Testers

**3213A**  
SERIES



- Analog models with single rating
- AC voltage measurement and check live lines such as motive power lines
- One-touch operation Press-and-lock switch for continuous measurement
- A wide choice of accessories to meet various testing requirements
- Vibration- and shock-resistant hand-held compact testers

## Testing Performance Specifications

Model	Rating	Effective Measuring Range	Central Scale Value	AC Voltage Measuring Range	Lower Limit of measured $\Omega$	Rated Current
321341	100V/20M $\Omega$	0.02–20M $\Omega$	0.5M $\Omega$	0–150V	0.1M $\Omega$	1mA
321342	250V/50M $\Omega$	0.05–50M $\Omega$	1M $\Omega$	0–250V	0.25M $\Omega$	1mA
321343	500V/100M $\Omega$	0.1–100M $\Omega$	2M $\Omega$	0–300V	0.5M $\Omega$	1mA
321344	500V/1000M $\Omega$	1–1000M $\Omega$	20M $\Omega$	0–300V	0.5M $\Omega$	1mA**
321345	1000V/2000M $\Omega$	2–2000M $\Omega$	50M $\Omega$	0–300V	1M $\Omega$	1mA**

\* The minimum value at which the rated voltage can be maintained; \*\* 0.55 mA in the case of the first effective measuring range

### Standard test conditions:

Ambient temperature/humidity ranges: 23  $\pm$  5 /45-75% RH

Position of use: Horizontal (5° max. of angle of inclination)

Effect of geomagnetism: None

Battery voltage: Within effective voltage range

(The pointer must stay within the range indicated by the BAT symbol when the battery check is performed.)

### Tolerances under the above-mentioned conditions:

Resistance measurement:

First effective measuring range =  $\pm$ 5% of reading

Second effective measuring range =  $\pm$ 10% of reading

Infinite and zero scale values: 0.7% max. of scale length

AC voltage:  $\pm$ 10% of maximum scale value

No-load voltage: 130% max. of rated voltage

Rated measuring current: 1 mA (0 to 20%) when in first effective measuring range

Short-circuit current: 12 mA max.

## General Specifications

Scale length: Approx. 88 mm

Dimensions (main unit): Approx. 110 (W)  $\times$  180 (H)  $\times$  60 (D) (mm)

Weight: Approx. 700 g including batteries, or approx. 1.2 kg including hard case, handle, test leads and batteries

Batteries: Eight AA (R6P) batteries

Accessories: See the list of accessories on the backside of this bulletin for information on accessories such as probes with a switch.

## Standard Accessories

Product	Part Number	Qty
Test lead	B9205VA	1 (consist of earth/line terminal)
Hard case	B9600HA	1 (w/leads-housing case)
Handle	B9303XE	1
User's manual	–	1
Batteries	–	8

## External Dimensions

Unit: mm

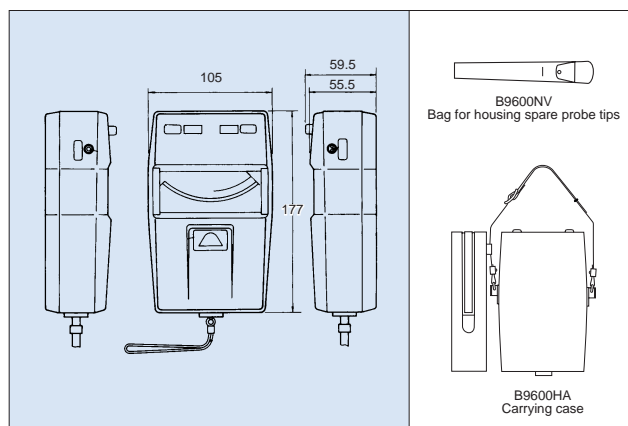

## Related Products

### Generator-driven Insulation Tester



#### Model 2404: (including case)

Dimensions: Approx. 112  $\times$  184  $\times$  105 (mm)  
Weight: Approx. 1.3 kg

### Earth Tester



#### Model 3235: (including case)

Dimensions: Approx. 210  $\times$  140  $\times$  135 (mm)  
Weight: Approx. 2.5 kg, including case

### Automatic Power Distribution Tester



#### Model 3207: (with case)

Dimensions: Approx. 210  $\times$  140  $\times$  142 (mm)  
Weight: Approx. 2.3 kg (main unit only)



# Quick-reference Table of Accessories for Insulation Testers

Series/Model			2404	3213A	2406E	2406D	MY10	MY40
Spare probe tip	For breaker pins	99011					○	○
	General-purpose	B9600GN		○				
	Hook-shaped	B9600NW		○				
	Extended	B9600NX		○				
	Sharp-pointed	B9600NZ		○				
	Pickax-shaped	B9635JK		○				
Probe	Line probe				98007	98007	98001	98001
	Earth probe				Earth and Line probes	Earth and Line probes	98002	98002
	Measuring Lead unit (Paired earth/line terminals)	B9634FA	B9205VA					
	Probe with switch		321802	B9204FX	B9204FX			
Case *1	Bag for housing spare probe tips		B9600NV					
	Accessory-housing case		B9646CA	B9108XA	B9108XA			
	Carrying case	B9634FF	B9600HA w/accessory-housing case	B9075MU (hard case) B9075MV (soft case) Note: Includes an accessory-housing case.			B9108XA 93015 Store main unit /accessories	B9108XA 93015 Store main unit /accessories
Others	Protection cover						93013	93013
	Shoulder strap						99005	99005
	Handle		B9303XE					
	Lead for guard terminals		321803	321803	321803			

○ denotes "applicable."

Note that the color of the plastic part of a probe tip may not always match that of the probe, depending on the combination.

\*1 Regarding external dimensions of cases, Pls refer to each product specification.

No.	Description	Remarks
①	Testing shank	Metal shank with ø6 screw
②	Fastening nut	ABS resin
③	PVC-clad	

## ■ Spare Probe Tips

Unit: mm

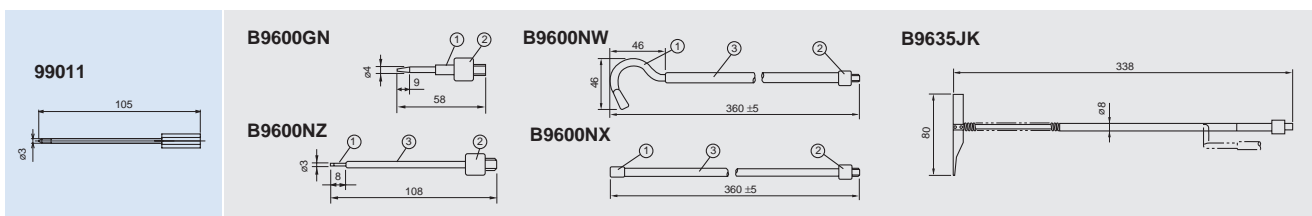

## ■ Probes

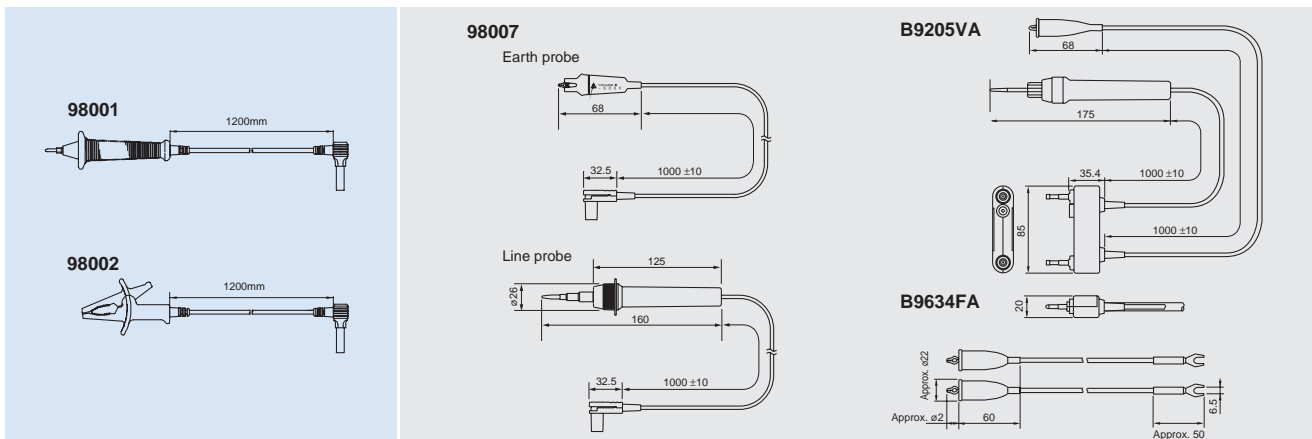

## ■ Probes with Switch

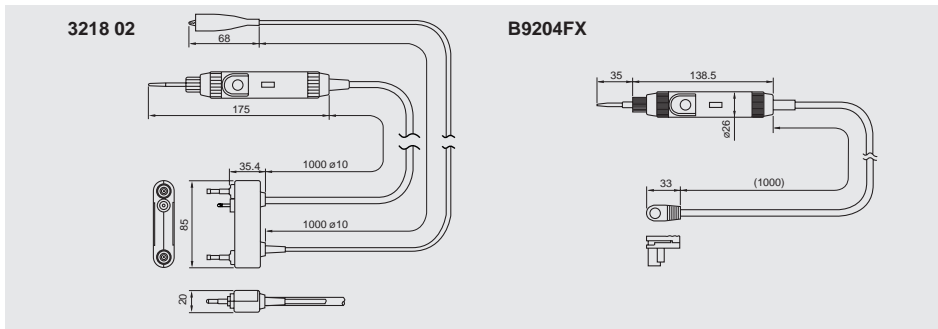

## ■ Others

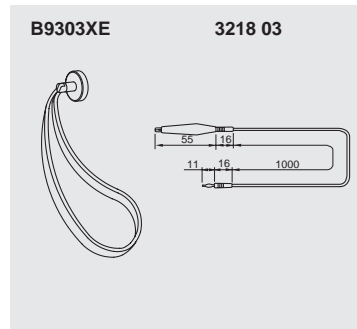

**YOKOGAWA**   
Yokogawa M&C Corporation

World Wide Web site at  
<http://www.yokogawa.com/MCC>

**NOTICE**

- Before using the product, read the instruction manual carefully to ensure proper and safe operation.

YOKOGAWA M&C CORPORATION Musashino Center Bldg.  
International Sales Dept. 1-19-18 Nakacho, Musashino-shi, Tokyo, 180-0006 Japan  
Phone: +81-422-55-8755 Facsimile: +81-422-55-8954

Represented by:

YOKOGAWA CORPORATION OF AMERICA (U.S.A.)	Phone: +1-770-253-7000	Facsimile: +1-770-251-2088
YOKOGAWA EUROPE B. V. (THE NETHERLANDS)	Phone: +31-334-64-1611	Facsimile: +31-334-64-1610
YOKOGAWA ENGINEERING ASIA PTE. LTD. (SINGAPORE)	Phone: +65-241-9933	Facsimile: +65-241-2606
YOKOGAWA AMERICA DO SUL LTDA (BRAZIL)	Phone: +55-11-5681-2400	Facsimile: +55-11-5681-1274/4434
YOKOGAWA MEASURING INSTRUMENTS KOREA CORPORATION (KOREA)	Phone: +82-2-551-0660 to 0664	Facsimile: +82-2-551-0665
YOKOGAWA AUSTRALIA PTY. LTD. (AUSTRALIA)	Phone: +61-2-9805-0699	Facsimile: +61-2-9888-1844
YOKOGAWA BLUE STAR LTD. (INDIA)	Phone: +91-80-227-1513	Facsimile: +91-80-227-4270
YOKOGAWA MIDDLE EAST E.C. (BAHRAIN)	Phone: +973-358100	Facsimile: +973-336100
LTD. YOKOGAWA ELECTRIC (RUSSIAN FEDERATION)	Phone: +7-095-737-7868	Facsimile: +7-095-737-7869

MCK-ES9